

Halley, a new universe

Design by **Jordi Vilardell & Meritxell Vidal**

HALLEY creates a new universe in outdoor lighting. Just like a comet, the arches of HALLEY generate a beam of light that pierces the night creating an extremely comfortable environment.

HALLEY can lit any outdoor space. It can be used to bathe tables or wider areas in a warm light that invites to live the night.

HALLEY is made of 3 basic shapes than can be combined in different ways depending on the space. All arches can be taken apart thus making it very easy to move them from one place to another.

...HALLEY, a new universe to be discovered.

Halley, un nuevo universo

Design by **Jordi Vilardell & Meritxell Vidal**

HALLEY descubre un nuevo universo en la iluminación de exterior. Como un cometa, los arcos HALLEY generan un haz de luz que cruza la noche creando un ambiente de máximo confort.

A través del sistema HALLEY cualquier espacio en el exterior puede ser iluminado. HALLEY permite iluminar mesas o áreas más amplias generando un ambiente cálido que invita a vivir la noche.

Tres formas básicas permiten realizar diferentes composiciones según el lugar que se quiera iluminar. Todos los arcos son desmontables por lo que pueden transportarse de un espacio a otro fácilmente.

...HALLEY, un nuevo universo por descubrir.



Easy assembly in any place

The visual lightness of the product hides an extremely technological lamp which responds to the most demanding needs of quality.

Instalar fácilmente en cualquier rincón

La ligereza visual del producto esconde una luminaria de alto valor técnico que responde a las más altas exigencias de calidad.

The HALLEY system has an IP64, a fact that makes it a water-proof outdoor lamp. The diffuser contains a strip of LEDs which delivers an incredible light effect through a perfect diffusion.

El sistema HALLEY cumple IP64 garantizando la estanqueidad en el exterior. El perfil difusor contiene iluminación LED consiguiendo un sorprendente efecto de luz a través de una difusión perfecta.

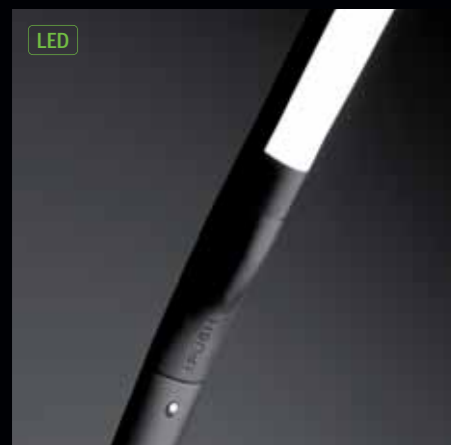

Each HALLEY arch is made of 3 sections that can be easily joined together by a click-on system. The bases have the same system to connect them to the sections. Cada arco HALLEY está compuesto por 3 piezas que se unen fácilmente entre sí con un simple 'click'. Las bases se conectan a los arcos con el mismo sistema.

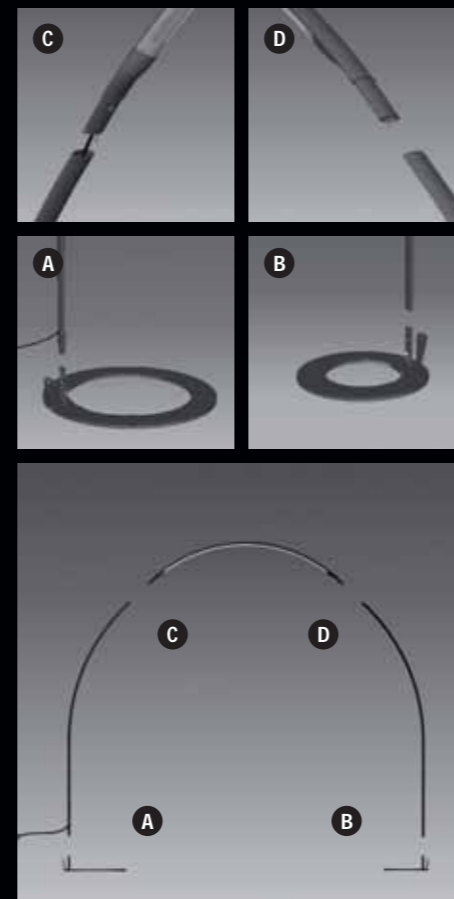

HALLEY is easy to move, assemble and disassemble, allowing it to be placed anywhere in a fast and simple way. HALLEY es de fácil transporte, montaje y desmontaje, permitiendo su instalación en cualquier rincón de forma rápida y sencilla.

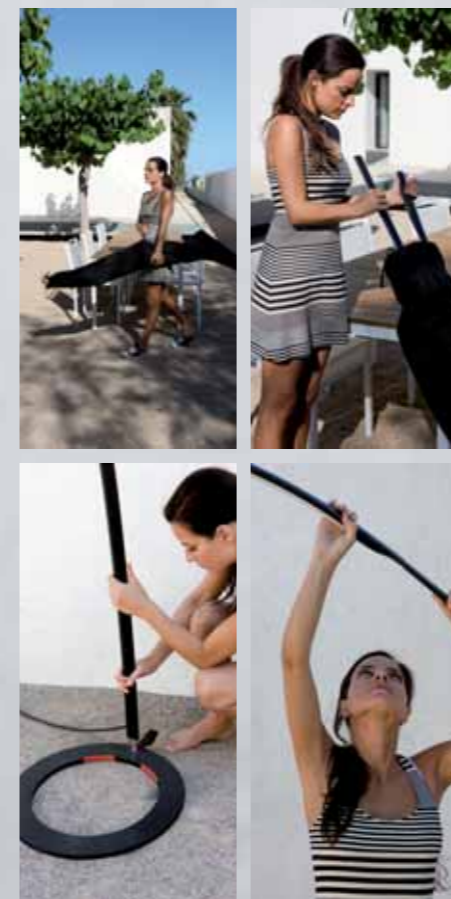

A configuration for any occasion

HALLEY is made of three basic shapes: floor-to-floor, floor-to-wall and floor-to-clamp. The arches can be connected one to the other offering different solutions to illuminate any space of a garden or terrace.

Una configuración para cada ocasión

HALLEY tiene tres formas básicas: suelo-suelo, suelo-pared y suelo-pinza. Estos arcos pueden conectarse entre sí ofreciendo soluciones para iluminar fácilmente cualquier situación y rincón del jardín o terraza.

Floor-to-floor / Suelo-suelo.

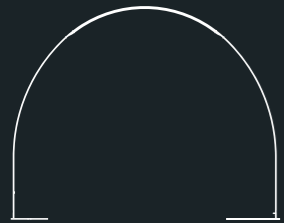

Floor-to-wall / Suelo-pared.

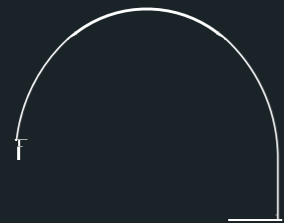

Floor-to-clamp / Suelo-pinza.



The arches can be easily connected one to the other by joining their bases.
Los arcos se conectan fácilmente entre sí uniendo las bases.

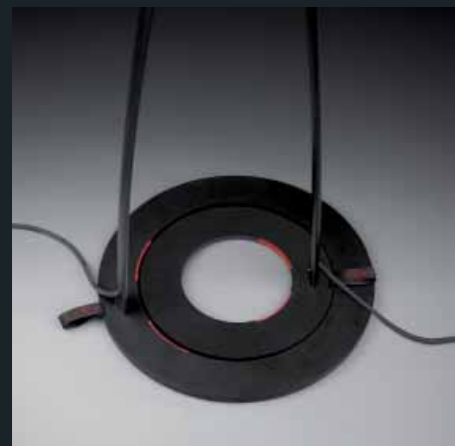

Floor-to-floor / Suelo-suelo.

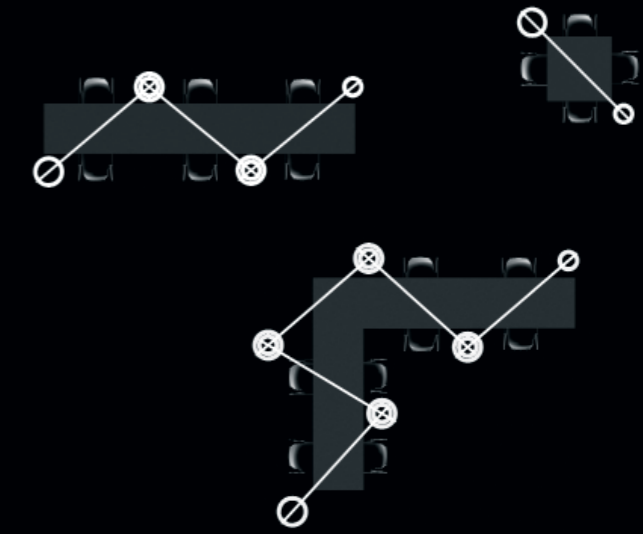

Floor-to-wall / Suelo-pared.

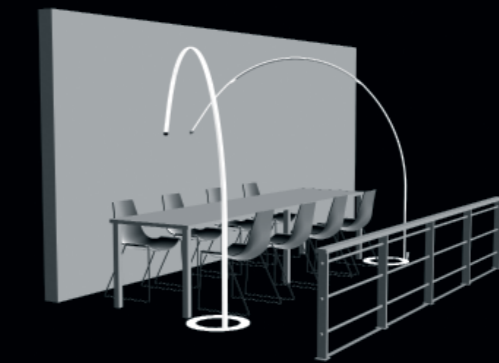
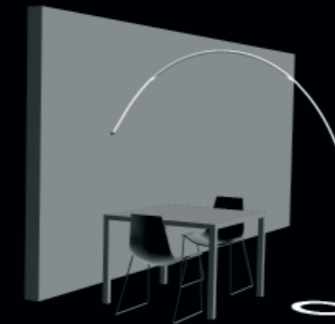

Floor-to-clamp / Suelo-pinza.

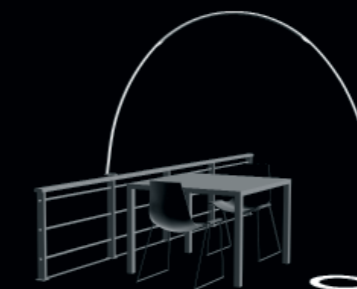

LED IP64

Halley

Design by Jordi Vilardell & Meritxell Vidal.

4155.

Black / Negro.

Polycarbonate diffuser / Difusor de policarbonato.

1x LED STRIP 12V 12W.

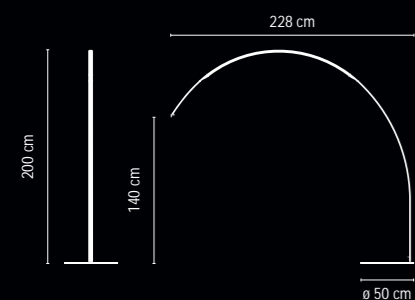

The arch can be fixed to the wall using screws. It can be removed, leaving the joint piece mounted on the wall / El arco se fija a la pared mediante tornillos. Puede retirarse el arco, dejando la unión fijada a la pared.

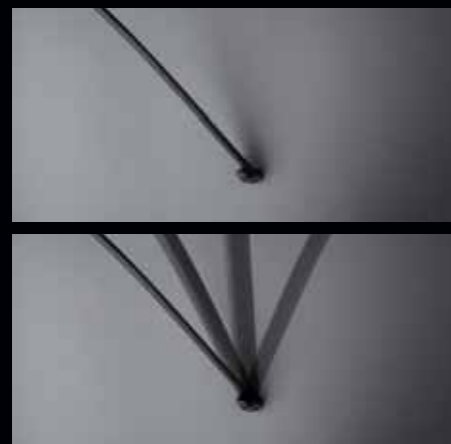

The Floor-To-Wall arch can be moved sideways, thus allowing any angle with respect to the wall / La unión a pared se puede orientar, por lo que cualquier ángulo a pared es posible.



HALLEY. Family / Familia

Paques / Páginas: A-462. B-464. C-466. D-468. E-468. F-468. G-468.

